

# EQUINOX DISTAL RADIUS SYSTEM 2021 KIT THREE

Case Information:

Date: \_\_\_\_\_

Surgeon: \_\_\_\_\_

Patient ID / Booking No.: \_\_\_\_\_

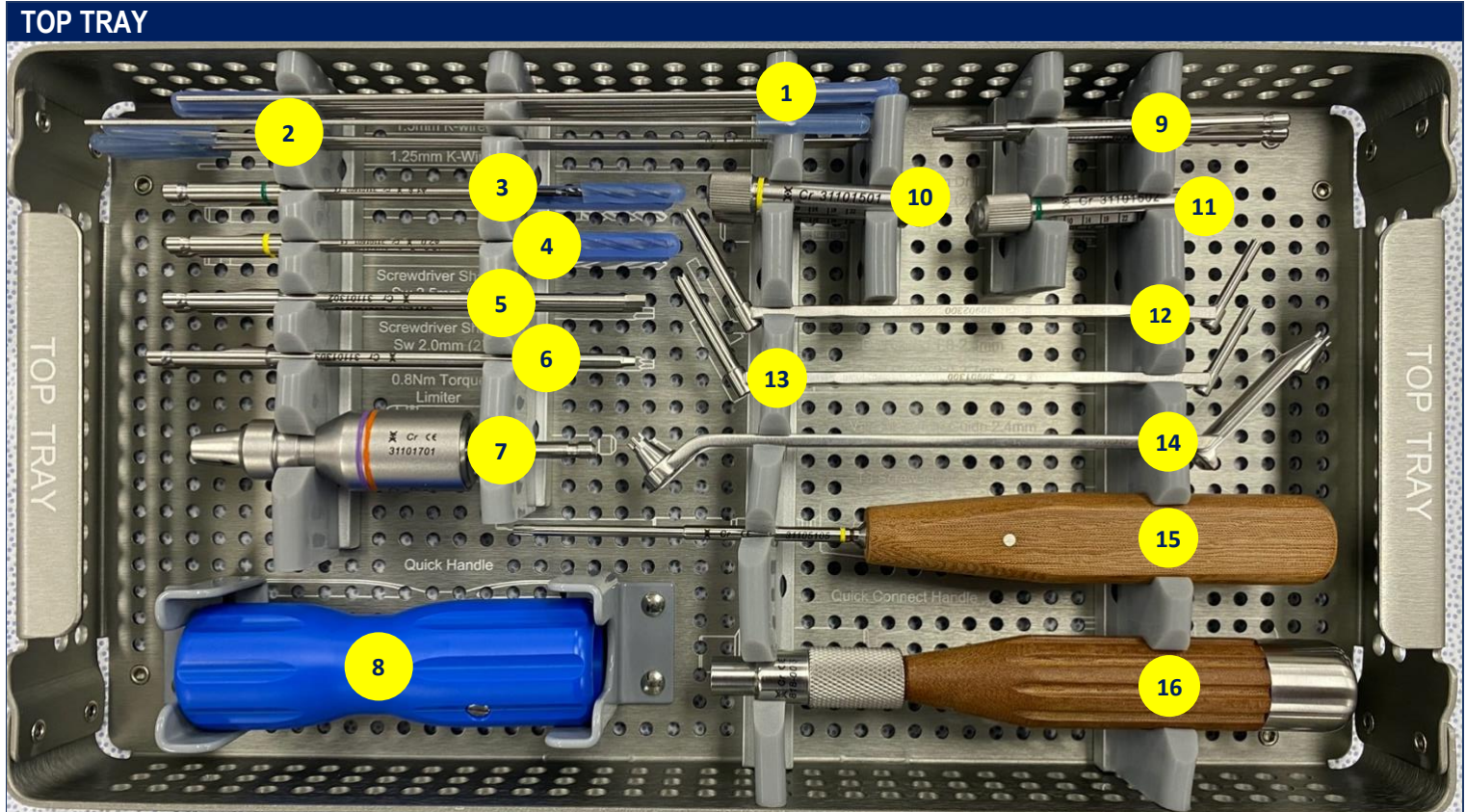

Product Code (Theatre Usage Code)	Barcode	Supplier Code	DISPOSABLE INSTRUMENTS (SINGLE USE)	Assembly	Standard Qty	CASE USAGE
1213		08.301.02.6090011	1. 1.5mm Guide Wire		5	
3897		08.301.02.30400112	2. 1.25mm Guide Wire		5	
4385		08.301.22.31101602	3. 1.8mm Drill Bit (Green)		2	
4384		08.301.22.31101601	4. 2.0mm Drill Bit (Yellow)		2	
Product Code (Theatre Usage Code)	Supplier Code	Number & Description		Assembly	Standard Qty	CASE USAGE
4378	31101302	5. 2.5mm Hex Screwdriver Shaft (2.7mm Cortex)			1	
4420	31105402	5. 2.5mm Hex Screwdriver Shaft (2.7mm Cortex) (Short)			1	
4413	31105100	6. 2.0mm Hex Screwdriver Shaft (2.4mm Cortex)			2	
4386	31101701	7. 0.8Nm Torque Limiting Attachment			1	
4578	34600600	8. Quick connect handle for Torque Limiter			1	

4424	31105402	9. T8 Stardrive Screwdriver Shaft		2	
4382	31101501	10. 2.0mm Screw in Drill Guide (Yellow)		2	
4383	31101502	11. 1.8mm Screw in Drill Guide (Green)		2	
4360	30902300	12. 1.8-2.4mm Drill Guide		1	
4355	30901300	13. 2.0-2.7mm Drill Guide		1	
4008	08.301.02.31404400	14. 2.4mm Variable Angle Drill Guide		1	
4417	31105105	15. T8 Star Screwdriver		1	
4787	818-005	16. Screwdriver Handle with Quick Coupling		1	

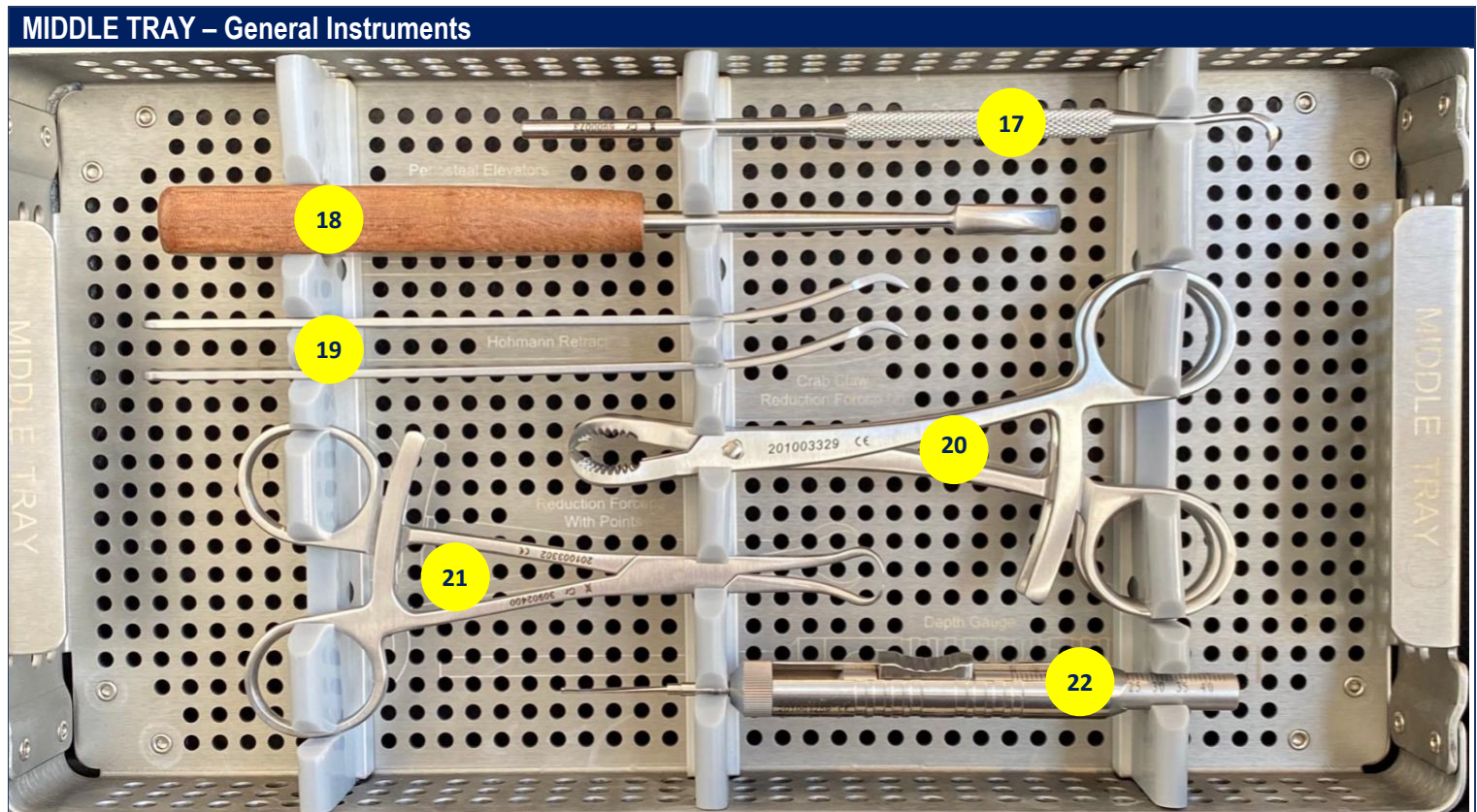







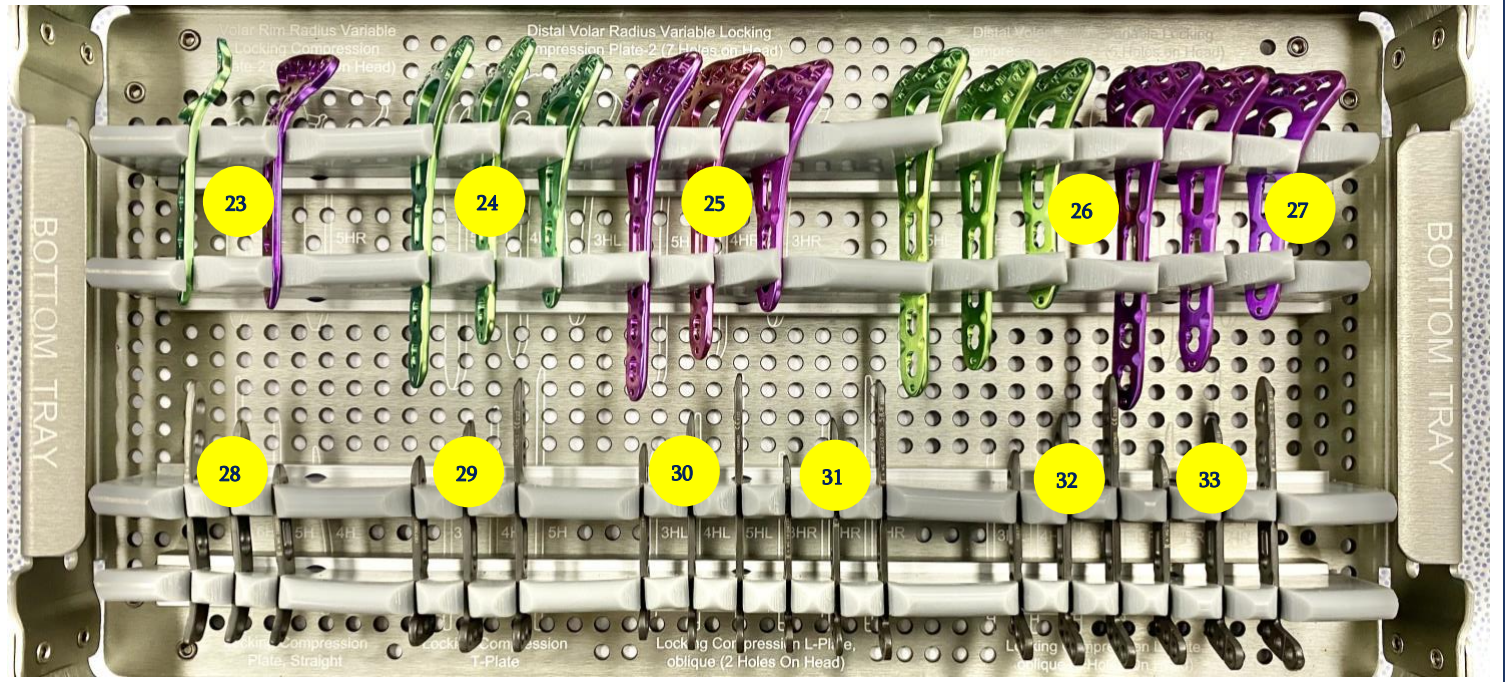

Product Code (Theatre Usage Code)	Supplier Code	Number & Description	Assembly	Standard Qty	CASE USAGE
4661	6900073	17. Sharp Hook		1	
4627	08.301.02.6900006	18. Periosteal Elevator, Round Edge		1	
4368	08.301.02.30905900	19. Baby Hohmann Retractors		2	
4462	31109400	20. Crab Claw Reduction Forceps		2	
4361	30902400	21. Reduction Forceps with Points		1	
4486	31402000	22. Depth Gauge for Mini Screws (2.0-2.7mm)	4 PARTS	1	









**BOTTOM TRAY**









Product Code (Theatre Usage Code)	Barcode	Supplier Code	Number & Description	Standard Qty	CASE USAGE
3125	 0106912547644545	08.311.01.140161705	23. Volar Rim Radius Distal Volar Locking Compression plate-2 (7 holes on head) 5 holes/LEFT	1	
3126	 0106912547644552	08.311.01.140162705	23. Volar Rim Radius Distal Volar Locking Compression plate-2 (7 holes on head) 5 holes/RIGHT	1	
3136	 0106912547644569	08.311.01.140167703	24. Distal Volar Radius Variable Locking Compression plate-2 (7 holes on head) 3 holes/LEFT	1	
3137	 0106912547644576	08.311.01.140167704	24. Distal Volar Radius Variable Locking Compression plate-2 (7 holes on head) 4 holes/LEFT	1	
3138	 0106912547644583	08.311.01.140167705	24. Distal Volar Radius Variable Locking Compression plate-2 (7 holes on head) 5 holes/LEFT	1	
3140	 0106912547644590	08.311.01.140168703	25. Distal Volar Radius Variable Locking Compression plate-2 (7 holes on head) 3 holes/RIGHT	1	
3141	 0106912547644606	08.311.01.140168704	25. Distal Volar Radius Variable Locking Compression plate-2 (7 holes on head) 4 holes/RIGHT	1	
3142	 0106912547644613	08.311.01.140168705	25. Distal Volar Radius Variable Locking Compression plate-2 (7 holes on head) 5 holes/RIGHT	1	







3128	 0106912547643739	08.311.01.140163703	Compression plate-1 (6 holes on head) 3 holes/LEFT	1	
3129	 0106912547643746	08.311.01.140163704	Compression plate-1 (6 holes on head) 4 holes/LEFT	1	
3130	 0106912547643753	08.311.01.140163705	Distal Ulnar Radius Variable Locking Compression plate-1 (6 holes on head) 5 holes/LEFT	1	
3131	 0106912547643777	08.311.01.140164703	Compression plate-1 (6 holes on head) 3 holes/RIGHT	1	
3132	 0106912547643784	08.311.01.140164704	Compression plate-1 (6 holes on head) 4 holes/RIGHT	1	
3133	 0106912547643791	08.311.01.140164705	Distal Ulnar Radius Variable Locking Compression plate-1 (6 holes on head) 5 holes/RIGHT	1	

2553	 0106912547001577	08.311.01.100735804	Plates, Straight, 4 holes (Radial Styloid plate)	1	
2554	 0106912547001584	08.311.01.100735805	Plates, Straight, 5 holes (Radial Styloid plate)	1	
2555	 0106912547001591	08.311.01.100735806	Plates, Straight, 6 holes (Radial Styloid plate)	1	

2546	 0106912547001423	08.311.01.100730803	29. Distal Radius Locking Compression T-Plate, 3 holes	1	
2547	 0106912547001430	08.311.01.100730804	29. Distal Radius Locking Compression T-Plate, 4 holes	1	
2548	 0106912547001447	08.311.01.100730805	29. Distal Radius Locking Compression T-Plate, 5 holes	1	

3112	 0106912547364108	08.311.01.101999803	30. Distal Radius Locking Compression L-Plate, oblique (2 holes on head), 3 Holes/LEFT	1	
3113	 0106912547364115	08.311.01.101999804	30. Distal Radius Locking Compression L-Plate, oblique (2 holes on head), 4 Holes/LEFT	1	
3114	 0106912547364122	08.311.01.101999805	30. Distal Radius Locking Compression L-Plate, oblique (2 holes on head), 5 Holes/LEFT	1	

<b>3115</b>	 0106912547364528	08.311.01.102008803	<b>31.</b> Distal Radius Locking Compression L-Plate, oblique (2 holes on head), 3 Holes/ <b>RIGHT</b>	1	
<b>3116</b>	 0106912547364535	08.311.01.102008804	<b>31.</b> Distal Radius Locking Compression L-Plate, oblique (2 holes on head), 4 Holes/ <b>RIGHT</b>	1	
<b>3117</b>	 0106912547364542	08.311.01.102008805	<b>31.</b> Distal Radius Locking Compression L-Plate, oblique (2 holes on head), 5 Holes/ <b>RIGHT</b>	1	





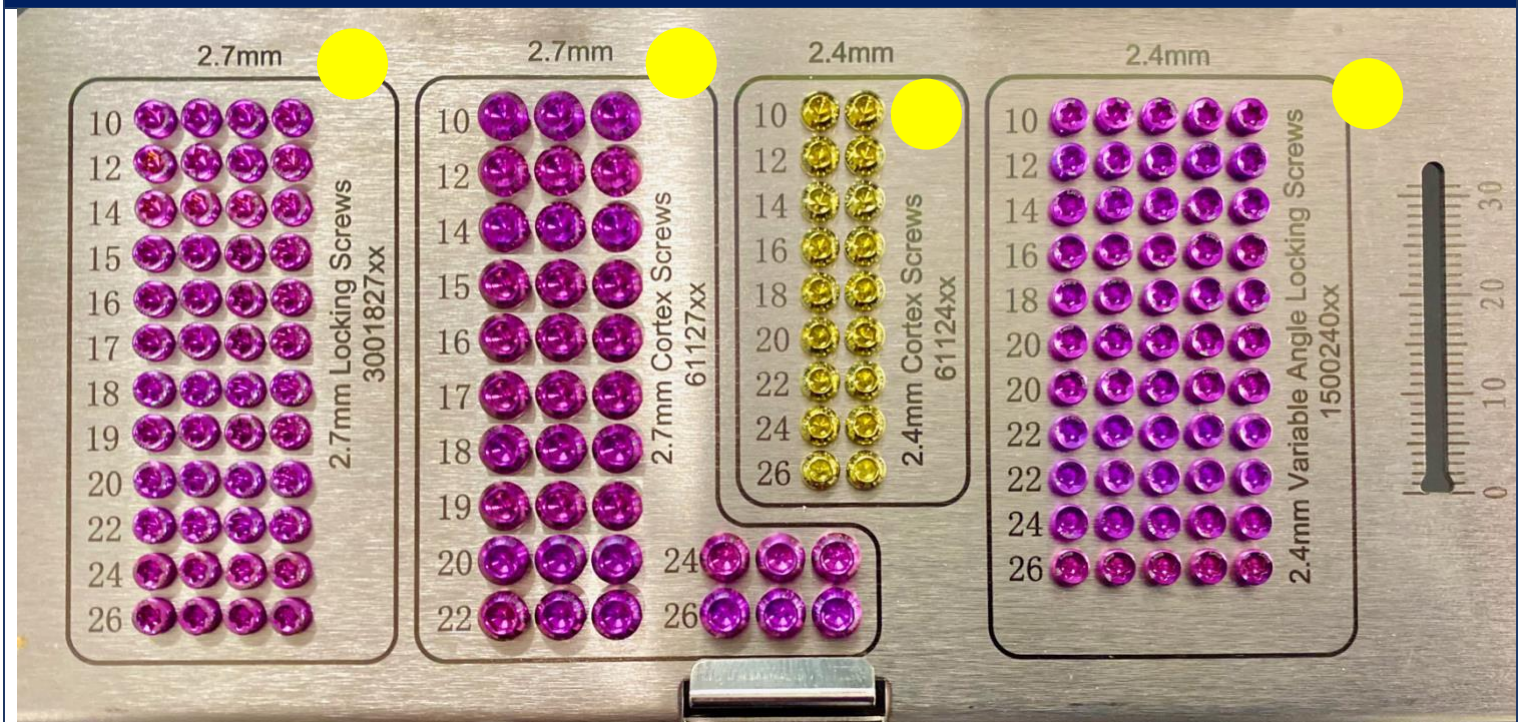

<b>2570</b>	 0106912547002406	08.311.01.100779803	<b>32.</b> Distal Radius Locking Compression L-Plate, oblique (3 holes on head), 3 Holes/ <b>LEFT</b>	1	
<b>2571</b>	 0106912547002413	08.311.01.100779804	<b>32.</b> Distal Radius Locking Compression L-Plate, oblique (3 holes on head), 4 Holes/ <b>LEFT</b>	1	
<b>2572</b>	 0106912547002420	08.311.01.100779805	<b>32.</b> Distal Radius Locking Compression L-Plate, oblique (3 holes on head), 5 Holes/ <b>LEFT</b>	1	
<b>2573</b>	 0106912547002543	08.311.01.100788803	<b>33.</b> Distal Radius Locking Compression L-Plate, oblique (3 holes on head), 3 Holes/ <b>RIGHT</b>	1	
<b>2574</b>	 0106912547002550	08.311.01.100788804	<b>33.</b> Distal Radius Locking Compression L-Plate, oblique (3 holes on head), 4 Holes/ <b>RIGHT</b>	1	
<b>2575</b>	 0106912547002567	08.311.01.100788805	<b>33.</b> Distal Radius Locking Compression L-Plate, oblique (3 holes on head), 5 Holes/ <b>RIGHT</b>	1	



















SCREW CADDY



Product Code (Theatre Usage Code)	Barcode	Supplier Code	Number & Description	Standard Qty	CASE USAGE
3378	 0106912547002857	08.311.01.300182710	1. 2.7mm Locking screw (2.7x10mm)	4	
3379	 0106912547002864	08.311.01.300182712	1. 2.7mm Locking screw (2.7x12mm)	4	
3380	 0106912547002871	08.311.01.300182714	1. 2.7mm Locking screw (2.7x14mm)	4	
3381	 06912547370154	08.311.01.300182715	1. 2.7mm Locking screw (2.7x15mm)	4	
3382	 0106912547002888	08.311.01.300182716	1. 2.7mm Locking screw (2.7x16mm)	4	
3383	 0106912547370017	08.311.01.300182717	1. 2.7mm Locking screw (2.7x17mm)	4	
3384	 0106912547002895	08.311.01.300182718	1. 2.7mm Locking screw (2.7x18mm)	4	
3385	 06912547370192	08.311.01.300182719	1. 2.7mm Locking screw (2.7x19mm)	4	

3386	 0106912547002901	08.311.01.300182720	1. 2.7mm Locking screw (2.7x20mm)	4	
3387	 0106912547002918	08.311.01.300182722	1. 2.7mm Locking screw (2.7x22mm)	4	
3388	 0106912547002925	08.311.01.300182724	1. 2.7mm Locking screw (2.7x24mm)	4	
3389	 0106912547002932	08.311.01.300182726	1. 2.7mm Locking screw (2.7x26mm)	4	
1659	 0106939488391475	08.301.11.6112710	2. 2.7mm Cortex screw (2.7x10mm)	3	
1660	 0106939488391482	08.301.11.6112712	2. 2.7mm Cortex screw (2.7x12mm)	3	
1661	 0106939488391499	08.301.11.6112714	2. 2.7mm Cortex screw (2.7x14mm)	3	
1662	 06912547371151	08.301.11.6112715	2. 2.7mm Cortex screw (2.7x15mm)	3	
1663	 0106939488391505	08.301.11.6112716	2. 2.7mm Cortex screw (2.7x16mm)	3	
1664	 06912547370178	08.301.11.6112717	2. 2.7mm Cortex screw (2.7x17mm)	3	
1665	 0106939488391512	08.301.11.6112718	2. 2.7mm Cortex screw (2.7x18mm)	3	
1666	 06912547371199	08.301.11.6112719	2. 2.7mm Cortex screw (2.7x19mm)	3	
1667	 0106939488391529	08.301.11.6112720	2. 2.7mm Cortex screw (2.7x20mm)	3	
1668	 0106939488391536	08.301.11.6112722	2. 2.7mm Cortex screw (2.7x22mm)	3	
1669	 0106939488391543	08.301.11.6112724	2. 2.7mm Cortex screw (2.7x24mm)	3	
1670	 0106939488391550	08.301.11.6112726	2. 2.7mm Cortex screw (2.7x26mm)	3	

1634	 0106939488399327	08.301.11.6112410	3. 2.4mm Cortex screw (2.4x10mm)	2	
1636	 0106939488399341	08.301.11.6112412	3. 2.4mm Cortex screw (2.4x12mm)	2	
1638	 0106939488399365	08.301.11.6112414	3. 2.4mm Cortex screw (2.4x14mm)	2	
1639	 0106939488399372	08.301.11.6112416	3. 2.4mm Cortex screw (2.4x16mm)	2	
1640	 0106939488399389	08.301.11.6112418	3. 2.4mm Cortex screw (2.4x18mm)	2	
1641	 0106939488399396	08.301.11.6112420	3. 2.4mm Cortex screw (2.4x20mm)	2	
1642	 0106939488399402	08.301.11.6112422	3. 2.4mm Cortex screw (2.4x22mm)	2	
1643	 0106939488399419	08.301.11.6112424	3. 2.4mm Cortex screw (2.4x24mm)	2	
1644	 0106939488399426	08.301.11.6112426	3. 2.4mm Cortex screw (2.4x26mm)	2	
3145	 0106912547645580	08.311.01.150024010	4. 2.4mm Variable Angle Locking screw (2.4x10mm)	5	
3146	 0106912547645597	08.311.01.150024012	4. 2.4mm Variable Angle Locking screw (2.4x12mm)	5	
3147	 0106912547645603	08.311.01.150024014	4. 2.4mm Variable Angle Locking screw (2.4x14mm)	5	
3148	 0106912547645610	08.311.01.150024016	4. 2.4mm Variable Angle Locking screw (2.4x16mm)	5	
3149	 0106912547645627	08.311.01.150024018	4. 2.4mm Variable Angle Locking screw (2.4x18mm)	5	
3150	 0106912547645634	08.311.01.150024020	4. 2.4mm Variable Angle Locking screw (2.4x20mm)	10	
3151	 0106912547645641	08.311.01.150024022	4. 2.4mm Variable Angle Locking screw (2.4x22mm)	10	
3152	 0106912547645658	08.311.01.150024024	4. 2.4mm Variable Angle Locking screw (2.4x24mm)	5	



3153	 0106912547645665	08.311.01.150024026	<b>4. 2.4mm Variable Angle Locking screw (2.4x26mm)</b>	5	
------	---	---------------------	---	---	--